

CHEF





Tjener- og kokketøj

High-end

Nogle gange skal det bare være lidt smartere, hvor det hele går op i en højere enhed med design, kvalitet og bæredygtighed. High-End giver en masse muligheder, hvis looket skal være trendy og kvaliteten bæredygtig.

High-end

Kokkeskjorte Oxford

- Vis altid kunden en vasket udgave, da den krøller lidt (giver hør look)
- Det anbefales at benytte forklæde med kryds på ryggen, da alm. forklæde gør at kraven folder i nakken
- Indsnit på ryg
- Nakkestrop til smækforklæde
- Integreret penlomme på venstre ærme
- 1 påsyet nylon knap i hals
- Skjulte trykknapper
- Ærmesnit som ikke løfter skjorten ved bevægelse
- Ærmer med nem Pull-Up cuff, så ærmet hurtigt kan trækkes op uden brug af ombuk

Størrelser	XS - 4XL
Materiale	70% bomuld / 30% polyester
Kvalitet	130 g/m ²
Leverandør	Kentaur
Certificering	Oeko-Tex standard 100 Oeko-Tex Made in Green Grüner Knopf ISO 15797

Varenr / Farve 35069 / Sand 



Vaskeriservice



STANDARD
100



MADE IN
GREEN

GRÜNER
KNOPF

SOZIAL. ÖKOLOGISCH. STAATLICH.
UNABHÄNGIG ZERTIFIZIERT.

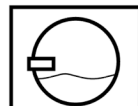

ISO 15797



High-end Kokkeskjorte Oxford dame

- **Vis altid kunden en vasket udgave, da den krøller lidt (giver hør look)**
- **Det anbefales at benytte forklæde med kryds på ryggen, da alm. forklæde gør at kraven folder i nakken**
- Figursyet med indsnit
- Brystindsnit
- Nakkestrop til smækforklæde
- Integreret penlomme på venstre ærme
- 1 påsyet nylon knap i hals
- Skjulte trykknapper
- Ærmesnit som ikke løfter skjorten ved bevægelse

Størrelser	XS - 4XL
Materiale	70% bomuld / 30% polyester
Kvalitet	130 g/m2
Leverandør	Kentaur
Certificering	Oeko-Tex standard 100 Oeko-Tex Made in Green Grüner Knopf ISO 15797

Varen / Farve 35391 / Sand



Vaskeriservice



STANDARD
100



MADE IN
GREEN



SOZIAL. ÖKOLOGISCH. STAATLICH.
UNABHÄNGIG ZERTIFIZIERT.

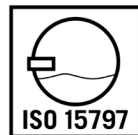



High-end

Kokkejakke I/æ Refibra

- TENCEL™ Lyocell x REFIBRA™
- Recycled polyester fra PET flasker
- Metervaren er let, blød og behagelig - vask efter vask
- Paspoleret brystlomme
- Trenset front med nem tilgang til trykknapper
- Skjulte trykknapper
- Nakkestrop til smækforklæde
- Indsnit på ryg
- Slids i siderne

Størrelser	XS - 4XL
Materiale	50% polyester / 50% CLY
Kvalitet	Hvid 235 g/m2 Sort 195 g/m2
Leverandør	Kentaur
Certificering	Oeko-Tex standard 100 Oeko-Tex made in green Repreve Grüner Knopf ISO 15797 Tencel x Refibra

Varenr / Farve	35587 / Hvid	
	35589 / Sort	

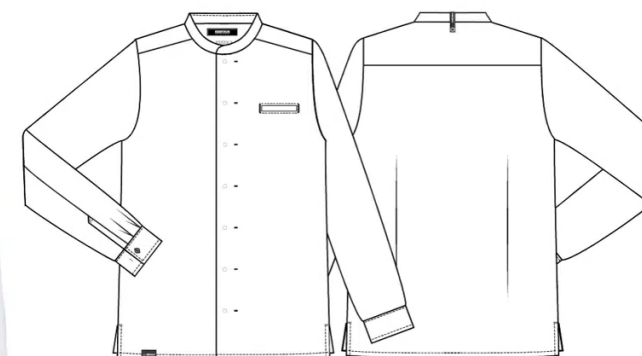

Vaskeriservice



STANDARD
100



MADE IN
GREEN

GRÜNER
KNOPF
SOZIAL. ÖKOLOGISCH. STAATLICH.
UNABHÄNGIG ZERTIFIZIERT.





ISO 15797

High-end

Kokkejakke k/æ Refibra

- Recycled polyester fra PET flasker
- Metervaren er let, blød og behagelig - vask efter vask
- Paspoleret brystlomme
- Trenset front med nem tilgang til trykknapper
- Skjulte trykknapper
- Nakkestrop til smækforklæde
- Slids i siderne

Størrelser	XS - 4XL
Materiale	50% CLY / 50% rPES
Kvalitet	Hvid 235 g/m2 Sort 195 g/m2
Leverandør	Kentaur
Certificering	Oeko-Tex standard 100 Oeko-Tex made in green Tencel x Refibra Repreve Grüner Knopf ISO 15797

Varenr / Farve	35586 / Hvid	
	35588 / Sort	

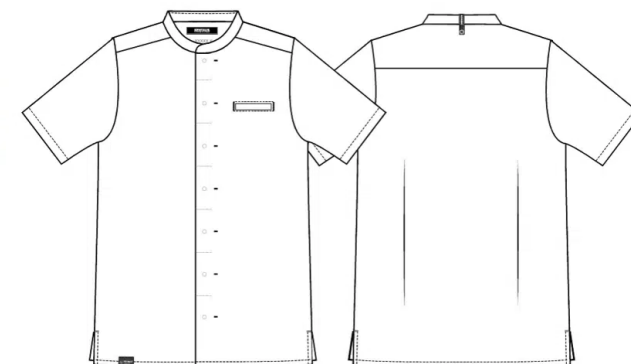

GRÜNER KNOPF

SOZIAL. ÖKOLOGISCH. STAATLICH.
UNABHÄNGIG ZERTIFIZIERT.

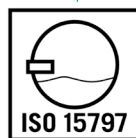

Vaskeriservis
STANDARD 100

MADE IN GREEN



High-end Kokkejakke

- 100% bomulds twill
- Our Choice
- Chefkokkejakke til kugleknapper

Størrelser 88-136

Materiale 100% CO

Kvalitet 210 g/m2

Leverandør Kentaur

Certificering Oeko-Tex standard 100
Oeko-Tex made in green
Grüner Knopf
ISO 15797

Varenr / Farve 12096 / Hvid

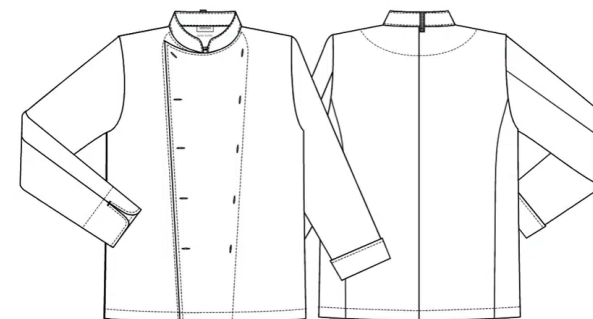

Vaskeriservice



STANDARD
100



MADE IN
GREEN

GRÜNER
KNOPF

SOZIAL, ÖKOLOGISCH, STAATLICH,
UNABHÄNGIG ZERTIFIZIERT.

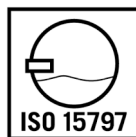

ISO 15797



High-end Kokkejakke, korte ærmer Workwear to Workwear

- Perfekte balance mellem design, funktionalitet og miljøhensyn
- Slids i begge sider
- Broderi bagpå kraven.
- Løkke i nakken for at holde forklædet på plads
- Produceret af 100 % genbrugsmaterialer, inklusive 60% af Elis' eget tekstilaffald

Størrelser XS - 6XL

Materiale 65% genanvendt polyester /
35% genanvendt bomuld

Kvalitet 230 g/m²

Leverandør EDSC

Varenr / Farve 35795 / Hvid

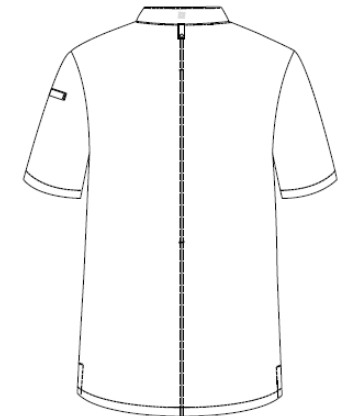
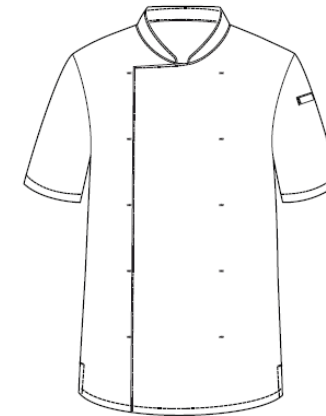

Vaskeriservice

High-end Kokkejakke, lange ærmer Workwear to Workwear

- Perfekte balance mellem design, funktionalitet og miljøhensyn
- Slids i begge sider
- Broderi bagpå kraven
- Løkke i nakken for at holde forklædet på plads
- Produceret af 100 % genbrugsmaterialer, inklusive 60% af Elis' eget tekstilaffald

Størrelser	XS - 6XL
Materiale	65% genanvendt polyester / 35% genanvendt bomuld
Kvalitet	230 g/m ²
Leverandør	EDSC
Varenr / Farve	35796 / Hvid 

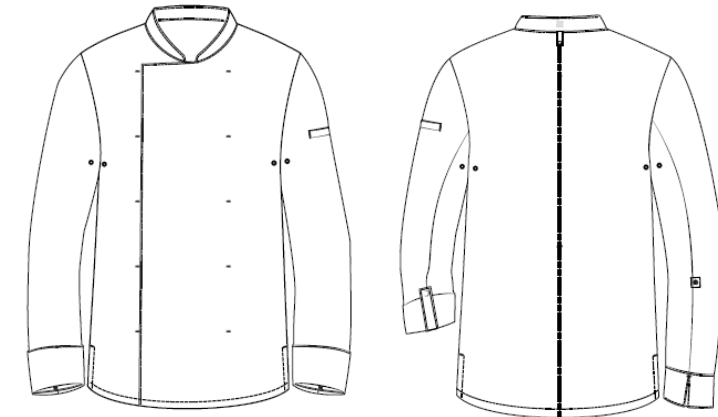

High-end Kokkejakke kortærmet

- Moderne fit og forbedret pasform
- Blanding af klassisk kokkejakke og moderne kokkeskjorte
- Kinakrave
- Nakkestroop til smækforklæde
- Skjulte, let tilgængelige trykknapper
- Manchetter
- Indsnit på ryg
- Slids i siderne

Størrelser XS - 4XL

Materiale 65% rPET polyester / 35% BCI bomuld

Kvalitet 175 g/m²

Leverandør Kentaur

Certificering Oeko-Tex standard 100
Oeko-Tex Made in Green
Repreve
Grüner Knopf
ISO 15797

Varenr / Farve 24059 / Hvid



12,1

plastikflasker er
genanvendt i
denne skjorte

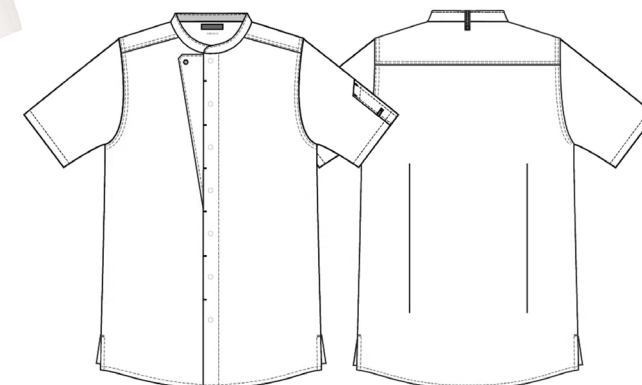

Vaskeriservice



STANDARD
100



MADE IN
GREEN



GRÜNER
KNOPF

SOZIAL, ÖKOLOGISCH, STAATLICH,
UNABHÄNGIG ZERTIFIZIERT.



High-end Kokke-/servicejakke

- Klassisk kokkejakke og moderne kokkeskjorte
- Bæredygtig metervare
- Nakkestrop til smækforklæde
- Modern fit - forbedret pasform

Størrelser XS - 4XL

Materiale 65% genbrugspolyester / 35% BCI-bomuld

Kvalitet 175 g/m²

Leverandør Kentaur

Certificering Oeko-Tex standard 100
Oeko-Tex Made in Green
Repreve
Grüner Knopf
ISO 15797

Varenr / Farve 26153 / Hvid

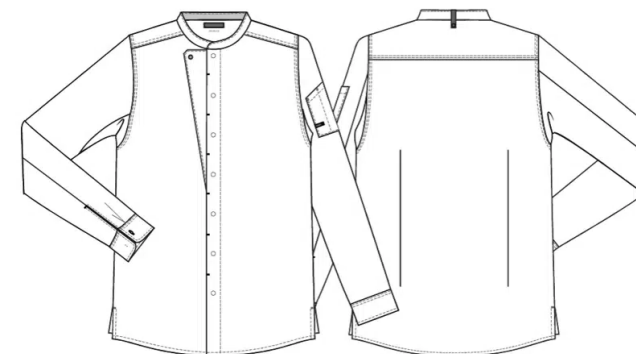

Vaskeriservice



STANDARD
100



MADE IN
GREEN



GRÜNER
KNOPF

SOZIAL. ÖKOLOGISCH. STAATLICH.
UNABHÄNGIG ZERTIFIZIERT.

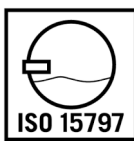

High-end Kokkejakke Med korte ærmer

- Natural stretch på kv. 143 - svarer til 4% stræk
- Modern fit - forbedret pasform
- Fusion af klassisk kokkejakke og moderne kokkeskjorte
- Kinakrave
- Nakkestroop til smækforklæde
- Trenset front med nem tilgang til trykknapper
- Skjulte trykknapper
- 1 synlig trykknop øverst
- Korte ærmer
- Todelt penlomme på venstre ærme
- Indsnit på ryg
- Slids i siderne

Størrelser XS - 4XL

Materiale 50 % bomuld / 50 % genanvendt polyester

Kvalitet 180 g/m²

Leverandør Kentaur

Certificering Oeko-Tex standard 100
Oeko-Tex Made in Green
Repreve
Grüner Knopf
ISO 15797

Varen / Farve 29317 / Oliven

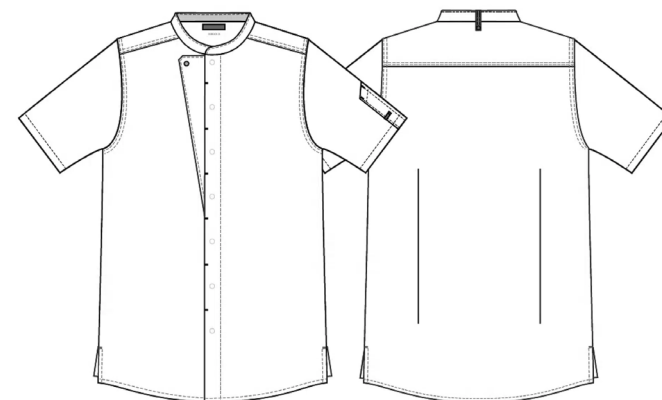

Vaskeriservice



STANDARD
100



MADE IN
GREEN



GRÜNER
KNOPF
SOZIAL. ÖKOLOGISCH. STAATLICH.
UNABHÄNGIG ZERTIFIZIERT.

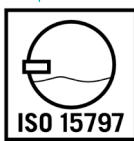

ISO 15797



High-end Kokkejakke Med lange ærmer

- Recycled polyester fra PET flasker
- Natural stretch = 4% stræk
- Modern fit - optimal pasform
- Nakkestrop til forklæde
- Ærmer med nem Pull-Up cuff, så ærmet hurtigt kan trækkes op uden brug af ombuk
- Ærmesnit der ikke løfter hele jakken ved bevægelse
- Todelt penlomme på venstre ærme
- Slids i siderne

Størrelser XS - 4XL

Materiale 50 % bomuld / 50 % genanvendt polyester

Kvalitet 180 g/m²

Leverandør Kentaur

Certificering Oeko-Tex standard 100
Oeko-Tex Made in Green
Repreve
Grüner Knopf
ISO 15797

Varenr / Farve 29947/ Oliven

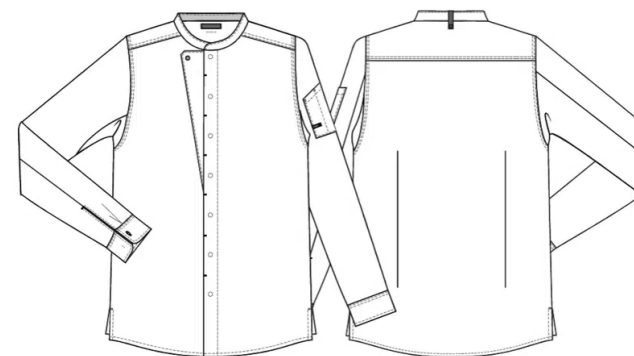

Vaskeriservice



STANDARD
100



MADE IN
GREEN



GRÜNER
KNOPF

SOZIAL. ÖKOLOGISCH. STAATLICH.
UNABHÄNGIG ZERTIFIZIERT.

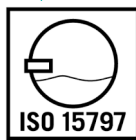

ISO 15797

 **elis**

High-end Kokkeskjorte

- "Stand up" krave
- Integreret penlomme på venstre ærme
- Skjulte trykknapper til snap-on forklæde
- Nakkestrop til smækforklæde
- Trenset front med nem tilgang til trykknapper
- Skjulte trykknapper
- Indsnit på ryg
- Lange ærmer med pull-up funktion
- Manchetter

Størrelser XS - 4XL

Materiale 65% genanvendt polyester / 35% bomuld

Kvalitet 150g /m2

Leverandør Kentaur

Certificering Oeko-Tex standard 100
ISO 15797

Varenr / Farve 29318 / Grå

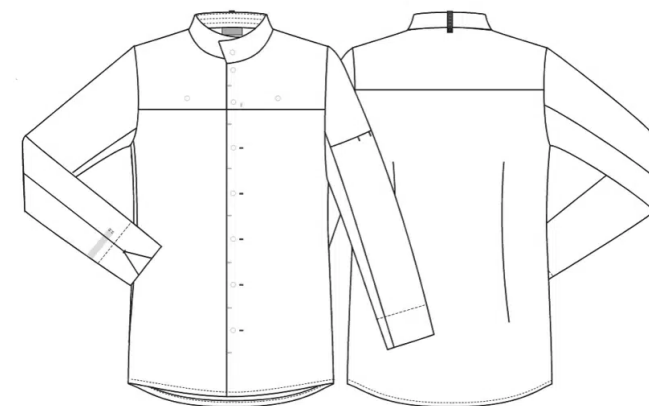

Vaskeriservice



STANDARD
100

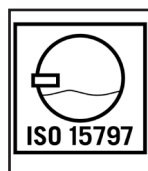

 **elis**

High-end Gourmet kokkejakke

- Modern fit
- Kinakrave
- Nakkestrop til smækforklæde
- Trenset front med nem tilgang til trykknapper
- Skjulte trykknapper
- Todelt penlomme på venstre ærme
- Diagonal trådretning i ryg, som giver øget komfort
- Korte ærmer
- Åndbart jersey under ærmer, som giver god komfort
- Ærmesnit der ikke løfter hele jakken ved bevægelse
- Slids i siderne

Størrelser	XS - 4XL
Materiale	50% polyester / 50% CLY
Kvalitet	215 g/m ²
Leverandør	Kentaur
Certificering	Oeko-Tex standard 100 Oeko-Tex Made in Green Grüner Knopf ISO 15797

Varenr / Farve 28765 / Hvid

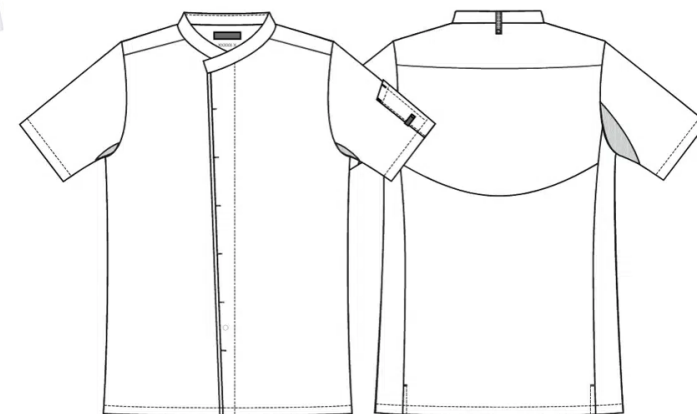

Vaskeriservice



STANDARD
100



MADE IN
GREEN



SOZIAL. ÖKOLOGISCH. STAATLICH.
UNABHÄNGIG ZERTIFIZIERT.

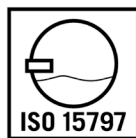

High-end Tencel Kokke-/serviceskjorte

- Modern fit
- Kinakrave
- Nakkestrop til smækforklæde
- Trenset front med nem tilgang til trykknapper
- Skjulte trykknapper
- Slids i siderne

Størrelser	XS - 4XL
Materiale	50% polyester / 50% CLY
Kvalitet	215 g/m ²
Leverandør	Kentaur
Certificering	Oeko-Tex standard 100 Oeko-Tex Made in Green Grüner Knopf ISO 15797
Varenr / Farve	29324 / Hvid 

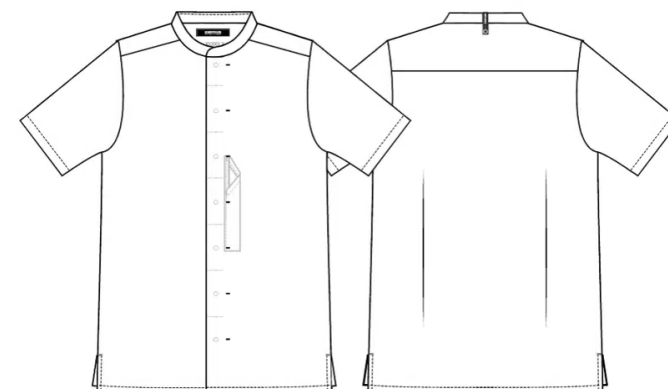

Vaskeriservice



STANDARD
100



MADE IN
GREEN

GRÜNER
KNOPF

SOZIAL. ÖKOLOGISCH. STAATLICH.
UNABHÄNGIG ZERTIFIZIERT.

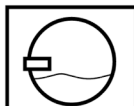

ISO 15797

High-end Kokkejakke langærmet Pisa

- Modern fit - optimal pasform
- Nakkestrop med trykknop til smækforklæde
- Ærmer med nem Pull-Up cuff, så ærmet hurtigt kan trækkes op uden brug af ombuk
- Ærmesnit der ikke løfter hele jakken ved bevægelse
- Todelt penlomme på venstre ærme
- Slids i siderne

Størrelser	XS - 4XL
Materiale	50% bomuld / 50% polyester
Kvalitet	180 g/m ²
Leverandør	Kentaur
Certificering	Oeko-Tex standard 100 Oeko-Tex Made in Green Grüner Knopf ISO 15797
Varen / Farve	35818 / Sand 

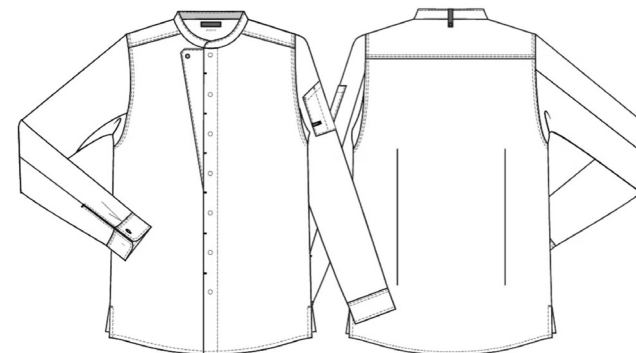

Vaskeriservice



STANDARD
100



MADE IN
GREEN

GRÜNER
KNOPF

SOZIAL. ÖKOLOGISCH. STAATLICH.
UNABHÄNGIG ZERTIFIZIERT.

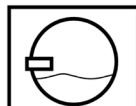

ISO 15797

 **elis**

High-end Kokkejakke kortærmet Pisa

- Modern fit - optimal pasform
- Nakkestrop med trykknop til smækforklæde
- Todelt penlomme på venstre ærme
- Slids i siderne

Størrelser	XS - 4XL
Materiale	50% bomuld / 50% polyester
Kvalitet	180 g/m2
Leverandør	Kentaur
Certificering	Oeko-Tex standard 100 Oeko-Tex Made in Green Grüner Knopf ISO 15797
Varen / Farve	35819 / Sand 

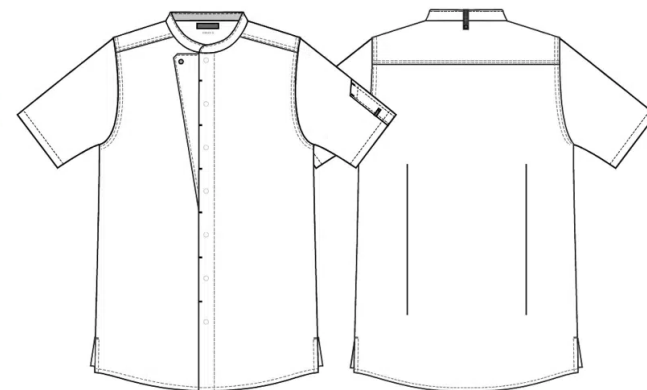

Vaskeriservice



STANDARD
100



MADE IN
GREEN



SOZIAL. ÖKOLOGISCH. STAATLICH.
UNABHÄNGIG ZERTIFIZIERT.

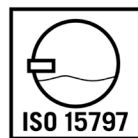

High-end Kokke-/service pique t-shirt

- Rund hals med blød jersey pique
- Udført i åndbart jersey som giver god komfort
- Komfort som polo og funktionel som skjorte
- Nakkebelægning
- Todelt brystlomme
- Korte ærmer
- Steamerstopper

Størrelser	XS - 4XL
Materiale	65% polyester / 35% bomuld
Kvalitet	150/230 g/m2
Leverandør	Kentaur
Certificering	Oeko-Tex standard 100 Oeko-Tex Made in Green Grüner Knopf ISO 15797
Varen / Farve	29316 / Sort 

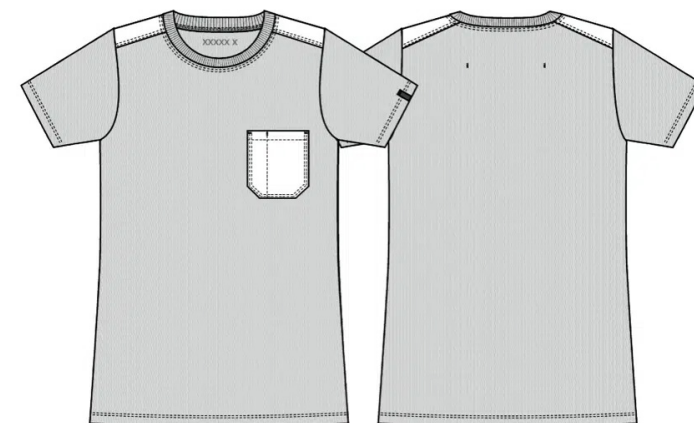

Vaskeriservice



STANDARD
100



MADE IN
GREEN

GRÜNER
KNOPF

SOZIAL. ÖKOLOGISCH. STAATLICH.
UNABHÄNGIG ZERTIFIZIERT.

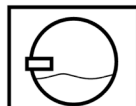

ISO 15797



High-end T-shirt m. nakkestrop

- Unisexmodel
- Nakkestrop med trykknop til smækforklæde
- Penlomme på venstre ærme
- Ekstra slidstærk
- Fire-lags halsrib
- Nakke- og skulderbånd
- Nakkespejl
- Forhøjet krave, som beskytter mod træk og fastholder nakkestroppen

Størrelser XS - 4XL

Materiale 60% bomuld / 40% polyester

Kvalitet 220 g/m²

Leverandør Kentaur

Certificering Oeko-Tex standard 100
ISO 15797

Varenr / Farve 39184 / Sort



39519 / Hvid

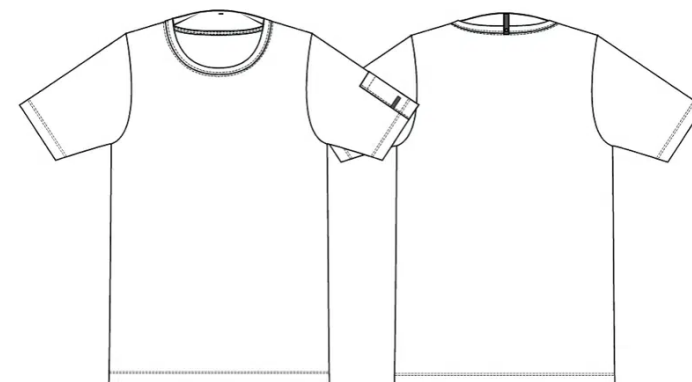

Vaskeriservice



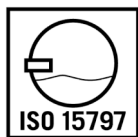

STANDARD
100



High-end re:Shirt

- Lavet af 100 % genanvendte materialer
- Heraf er 45 % fra kasserede tekstiler, resten rPet
- Udleder mindre CO₂ i produktionen og forbruger mindre landareal og vand iff. konventionelle t-shirts

Størrelser	XS-6XL
Materiale	70% genanvendt polyester (15% post-consumption og 55% rPet) 30% genanvendt bomuld (15% post-consumption og 15% pre-consumption)
Kvalitet	215 g/m ²
Leverandør	Hviid Hviid By Jbs
Certificering	Oeko-Tex standard 100 Global Recycled Standard
Vare / Farve	29983 / Hvid  29960 / Blå melange 



GWP
2,35 kg CO₂eq/stk)



Landarealforbrug
0,042 m²a crop eq/stk



Vandforbrug
0,012 m³



GWP
1,57 kg CO₂eq/stk)



Landarealforbrug
0,032 m²a crop eq/stk



Vandforbrug
0,0099 m³

High-end Active Flex Buks

- Stretchkvalitet
- Elastik i bag
- Justerbar talje
- Bæltestropper
- 2 forlommer
- 1 baglomme
- Stempellap
- Lårlomme med trykknop
- Justerbar benlængde ved brug af elastik og knap

Størrelser	XS - 4XL
Materiale	50% rPES / 50% PBT
Kvalitet	110 g/m ²
Leverandør	Kentaur
Certificering	Oeko-Tex standard 100 Oeko-Tex made in green Repreve Grüner Knopf ISO 15797

Varen / Farve 29325 / Sort

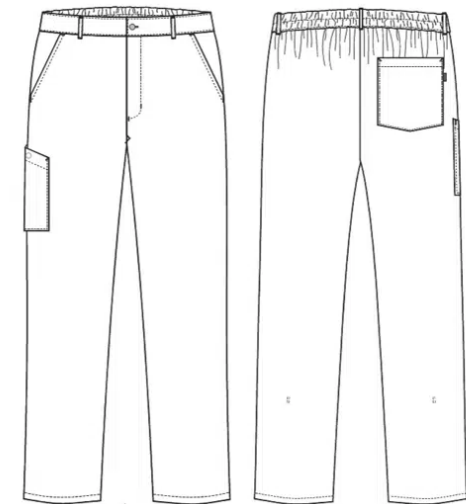

Vaskeriservice



STANDARD
100



MADE IN
GREEN

**GRÜNER
KNOPF**
SOZIAL. ÖKOLOGISCH. STAATLICH.
UNABHÄNGIG ZERTIFIZIERT.

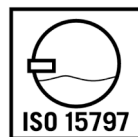

High-end Active Buks

- Stretchkvalitet
- Elastik i linning
- 2 forlommer
- 1 baglomme
- Lårlomme med trykknop
- Justerbar benlængde ved brug af elastik og knap

Størrelser	XS - 4XL
Materiale	100% Polyester
Kvalitet	110 g/m ²
Leverandør	Kentaur
Certificering	Oeko-Tex standard 100
Varenr / Farve	27129/ Sort 



 again

Again-produkter indeholder
minimum 50% genanvendte
materialer



Vaskeriservice



STANDARD
100



High-end Raw Smækforklæde

- Nakkestrop kan justeres med knap og knaphuller
- Baristastrop
- Knapper er egnede til rulning
- Syede bånd
- Stropper til at hænge op ved dampning

Størrelser 90 x 84

Materiale 65% rPET polyester / 35% BCI bomuld

Kvalitet 245 g/m²

Leverandør Kentaur

Certificering Oeko-Tex standard 100
Oeko-Tex made in green
Repreve
Grüner Knopf
ISO 15797

Varenr / Farve 26149 / Oliven



11,4

plastikflasker er
genanvendt i
dette forklæde

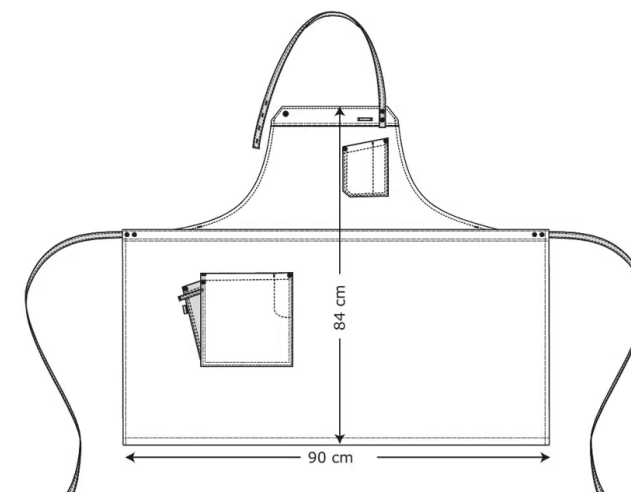

Vaskeriservice



STANDARD
100



MADE IN
GREEN

GRÜNER
KNOPF

SOZIAL, ÖKOLOGISCH, STAATLICH,
UNABHÄNGIG ZERTIFIZIERT.



High-end

Raw smækforklæde

- Justerbar nakkestrop med knap og knaphul
- 1 todelt brystlomme og 1 hoftelomme
- Baristastrop
- Steamerstrop
- Smæk kan bukkes om, så det kan bruges som tjenerforklæde

Størrelser	90 x 84 cm
Materiale	60% polyester / 40% bomuld
Kvalitet	325 g/m ²
Leverandør	Kentaur
Certificering	Oeko-Tex standard 100 Oeko-Tex made in green Repreve Grüner Knopf ISO 15797

Varenr / Farve

22868 / Sort



22864 / Khaki

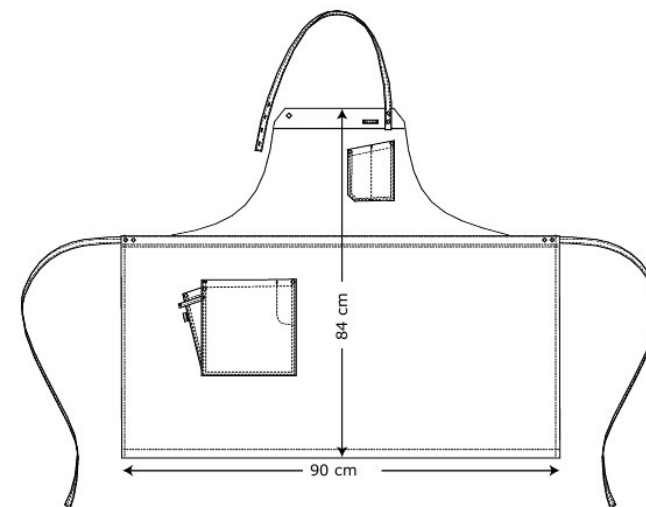

Vaskeriservice



STANDARD
100



MADE IN
GREEN

GRÜNER
KNOPF

SOZIAL, ÖKOLOGISCH, STAATLICH,
UNABHÄNGIG ZERTIFIZIERT.

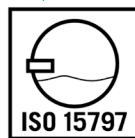

High-end Zero waste apron

- 100% genanvendte materialer, hvoraf 60% er Elis egne kasserede tekstiler
- Produceret uden materialespild
- Med smæk og lange bindebånd, der danner et X på ryggen

Størrelser One size B: 70 x H: 98 cm

Materiale 65% genbrugspolyester / 35% genbrugsbomuld

Kvalitet 235 g/m²

Leverandør Elis

Certificering Oeko-Tex standard 100

Varenr / Farve 35166 / Grå melange

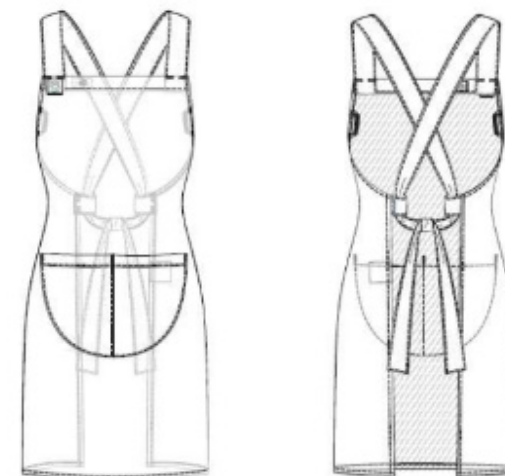

Skabeloner til produktion af 3 forklæder

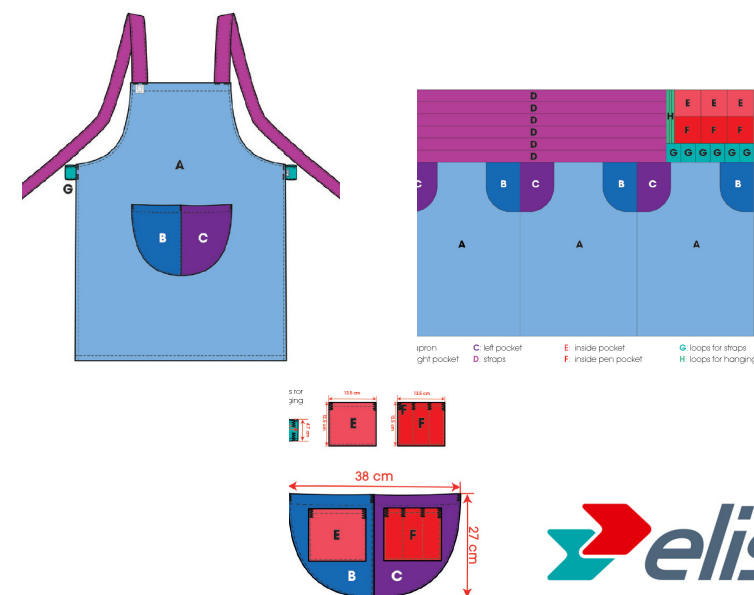

Vaskeriservice



STANDARD
100

High-end

Waist Apron Grey

Zero waste

- 100% genanvendte materialer, hvoraf 60% er Elis egne kasserede tekstiler
- Produceret uden materialespild
- UHF chip

Størrelser One size B: 75 x H: 42 cm

Materiale 65% genbrugspolyester / 35% genbrugsbomuld

Kvalitet 235 g/m²

Leverandør Elis

Certificering Oeko-Tex standard 100

Varenr / Farve 35263 / Grå melange

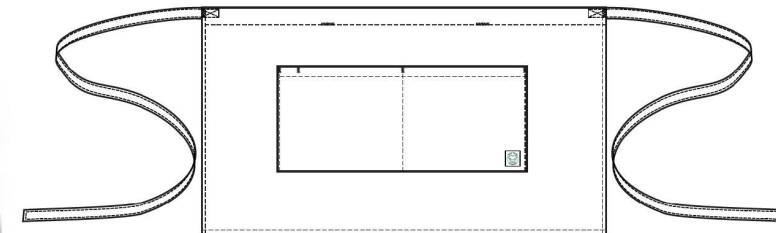
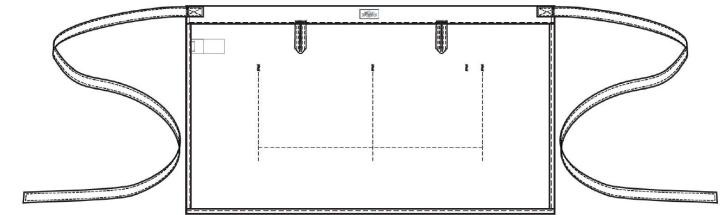

Vaskeriservice



STANDARD
100

High-end Bib Apron Denim Zero waste

- 100% genanvendte materialer, hvoraf 85% er Elis egne kasserede tekstiler
- Produceret uden materialespild
- Med smæk og lange bindebånd, der danner et X på ryggen

Størrelser Onesize B: 70 x H: 98 cm

Materiale 62% genbrugspolyester, 28% genbrugsbomuld / 10% andet genbrugt fiber

Kvalitet 230 g/m²

Leverandør ELIS

Certificering Oeko-Tex standard 100

Varen / Farve 35385 / Denim 

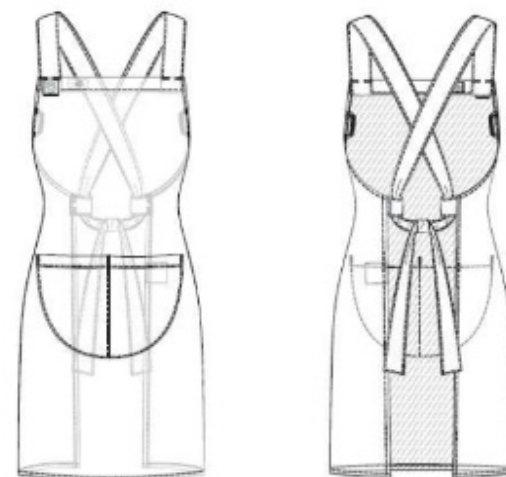

Skabeloner til produktion af 3 forklæder

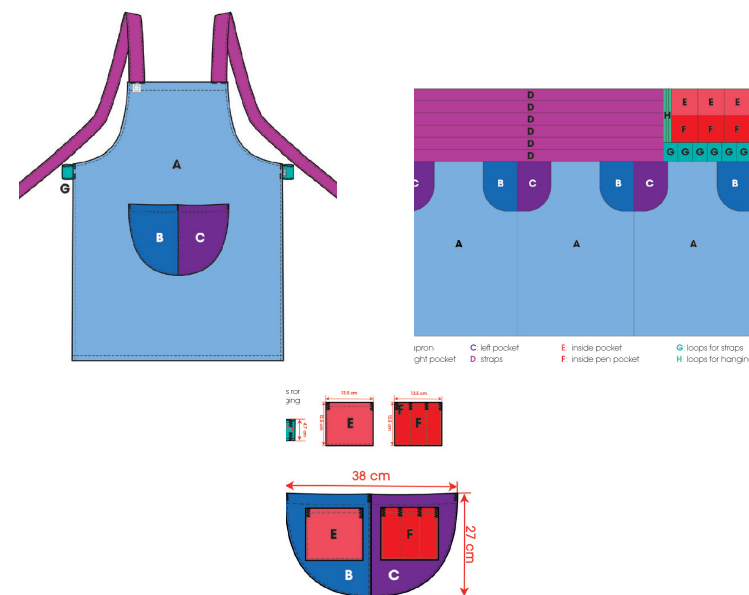

Vaskeriservice



STANDARD
100



High-end Forklæde

- Bib-forklæde med elastiske seler og dobbeltlomme
- Elastiske seler sælges separat
- Slidstærkt stof

Størrelser One size B: 75 x H: 90 cm

Materiale 65% genbrugspolyester / 35% genbrugsbomuld

Kvalitet 400 g/m²

Leverandør Segers

Certificering Oeko-Tex standard 100
Oeko-Tex made in green

Varen / Farve 28150 / Dark grey



35993 / Dark olive green



39175 / Sort



39193 / Navy



Vaskeriservice



STANDARD
100



MADE IN
GREEN



High-end

Elastik seler til forklæde

- Seler, der fastgøres med læderstropper og metalknapper
- Justerbare elastiske seler
- Passer til forklæde 28150, 35993, 39175 og 39193

Størrelser S/M (54–80 cm)
L/XL (68–108 cm)

Materiale Elastik/læder

Kvalitet 110-140 g/m²

Leverandør Segers

Varenr / Farve 35994 / Brun



39174 / Sort

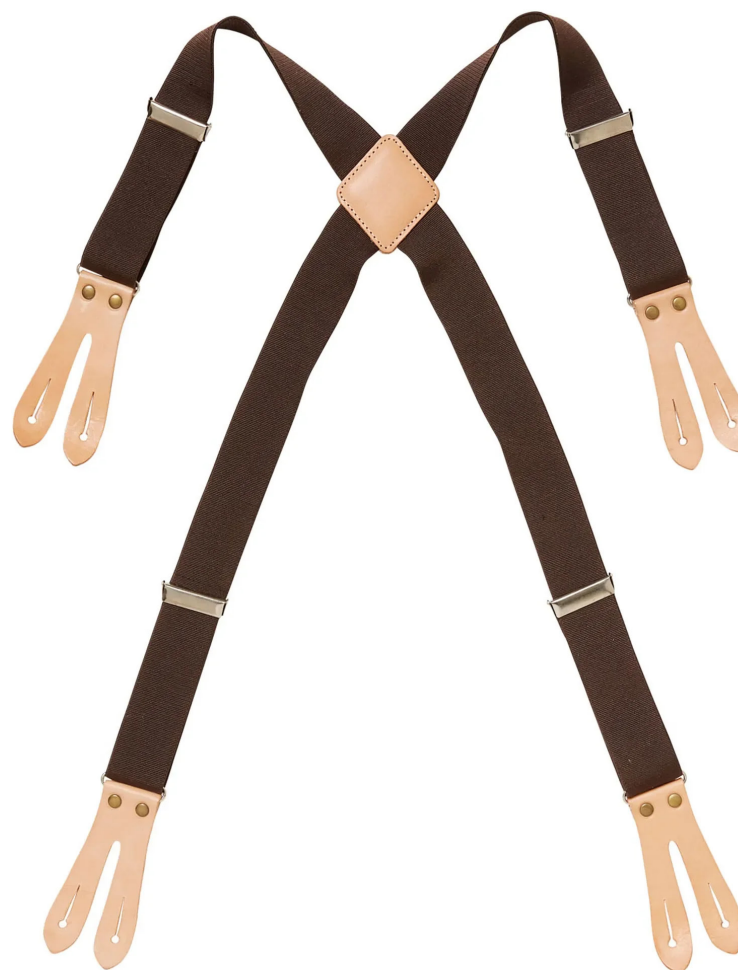

Vaskeriservice





Tjener- og kokketøj

Classic

At noget er enkelt, er en kvalitet i sig selv. Pure er basistøj som bekræfter det vigtige i et solidt fundament og værdien af at holde i længden. Nogle gange er det enkle det bedste.

Classic

Kokkeskjorte

- Lange ærmer
- Kinakrave
- Moderne og optimalt fit
- Nakkestrop til forklæde
- Slids i siderne
- Lomme til kuglepen på ærme

Størrelser XS - 6XL

Materiale 65% genbrugspolyester / 35% BCI-bomuld

Kvalitet 175 g/m²

Leverandør Kentaur

Certificering Oeko-Tex standard 100
Oeko-Tex made in green
Grüner Knopf
ISO 15797

Varenr / Farve 22694 / Hvid



14

plastikflasker er
genanvendt i
denne skjorte

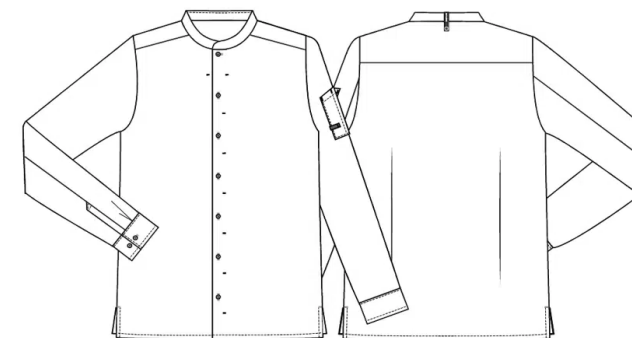

Vaskeriservice



STANDARD
100



MADE IN
GREEN

GRÜNER
KNOPF

SOZIAL, ÖKOLOGISCH, STAATLICH,
UNABHÄNGIG ZERTIFIZIERT.

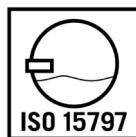

Classic

Kokkeskjorte, lange ærmer

- Lange ærmer
- Moderne og optimalt fit
- Kinakrave
- Kontrastfarve på inderside af krave
- Slids i siderne og indsnit på ryg
- Lomme til kuglepen på venstre ærmer
- Nakkestrop til forklæde

Størrelser XS - 6XL

Materiale 65% polyester / 35% bomuld

Kvalitet 175 g/m²

Leverandør Kentaur

Certificering Oeko-Tex standard 100
Oeko-Tex made in green
Repreve
Grüner Knopf
ISO 15797

Varenr / Farve 23346 / Sort

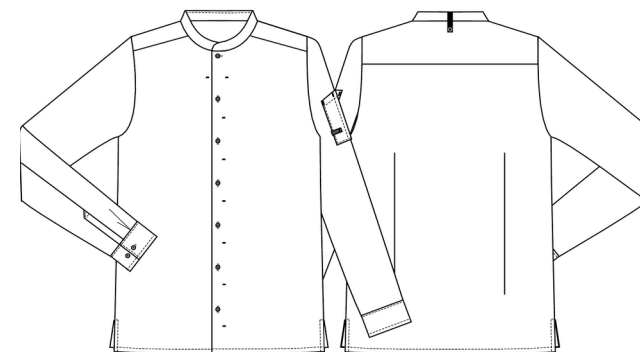

Vaskeriservice



STANDARD
100



MADE IN
GREEN

GRÜNER
KNOPF

SOZIAL. ÖKOLOGISCH. STAATLICH.
UNABHÄNGIG ZERTIFIZIERT.



Classic

Kokkeskjorte, korte ærmer

- Kinakrave
- Moderne og optimalt fit
- Kontrastfarve indvendig i kraven
- Påsyede knapper med kontrast tråd
- Nakkestrop til smækforklæde
- Todelt penlomme på venstre ærme
- Indsnit på ryg
- Slids i siderne

Størrelser XS - 4XL

Materiale 65% polyester / 35% BCI bomuld

Kvalitet 175 g/m²

Leverandør Kentaur

Certificering Oeko-Tex standard 100
Oeko-Tex made in green
Repreve
Grüner Knopf
ISO 15797

Varenr / Farve 23610 / Hvid

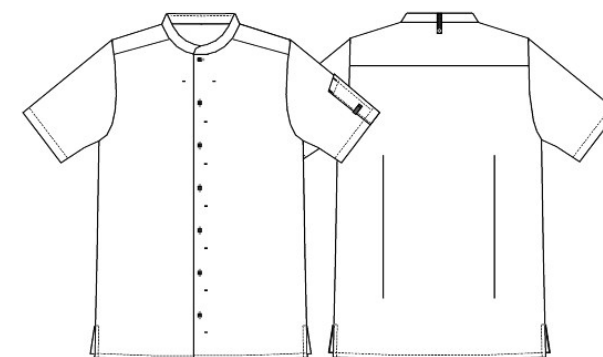

Vaskeriservice



STANDARD
100



MADE IN
GREEN

GRÜNER
KNOPF

SOZIAL ÖKOLOGISCH STAATLICH
UNABHÄNGIG ZERTIFIZIERT



ISO 15797



Classic Kokkeskjorte

- Kinakrave
- Moderne og optimalt fit
- Kontrastfarve indvendig i kraven
- Påsyede knapper med kontrast tråd
- Nakkestrop til smækforklæde
- Todelt penlomme på venstre ærme
- Indsnit på ryg
- Slids i siderne

Størrelser	XS - 6XL
Materiale	65% rPET polyester / 35% BCI bomuld
Kvalitet	175 g/m2
Leverandør	Kentaur
Certificering	Oeko-Tex standard 100 Oeko-Tex made in green Repreve Grüner Knopf ISO 15797
Varenr / Farve	22869 / Sort 



11,2

plastikflasker er
genanvendt i
denne skjorte

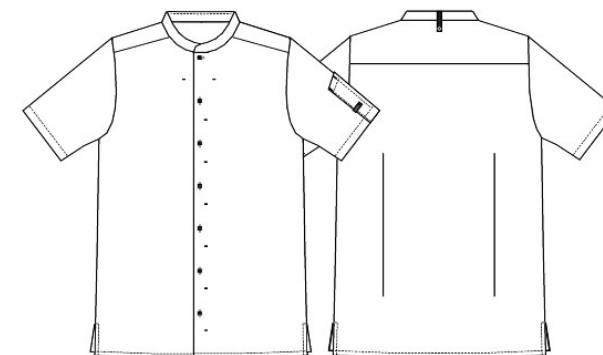

Vaskeriservice



STANDARD
100



MADE IN
GREEN



SOZIAL. ÖKOLOGISCH. STAATLICH.
UNABHÄNGIG ZERTIFIZIERT.



Classic

Herrebuks m. smalle ben

- Herrebukser med smalle ben
- God stretch og lav livhøjde
- Moderne snit

Størrelser 64 - 144

Materiale 65% polyester / 35% bomuld

Kvalitet 245 g/m²

Leverandør Nybo

Certificering Oeko-Tex standard 100
Oeko-Tex made in green
Oeko-Tex STeP

Varenr / Farve 23266 / Sort 



Vaskeriservice



STANDARD
100



MADE IN
GREEN



STeP



Classic

Damebukse m. smalle ben

- Damebukser med smalle ben
- God stretch og lav livhøjde
- Moderne snit

Størrelser 30 - 66

Materiale 65% polyester / 35% bomuld

Kvalitet 245 g/m²

Leverandør Nybo

Certificering Oeko-Tex standard 100

Varenr / Farve 23295 / Sort



Vaskeriservice



STANDARD
100



Classic

Smækforklæde, bredt

- Indvendig brystlomme på smækforklædet
- Indvendige mål på lomme: H: 20 cm x B: 16,5 cm
- Nakkestrop kan justeres med knap og knaphuller
- Knapper er egnede til rulning
- Syede bånd
- Stropper til at hænge op ved dampning

Størrelser	One size
Materiale	65% rPET polyester / 35% BCI bomuld
Kvalitet	245 g/m ²
Leverandør	Kentaur
Certificering	Oeko-Tex standard 100 Oeko-Tex Made in Green
Varenr / Farve	26152 / Oliven 

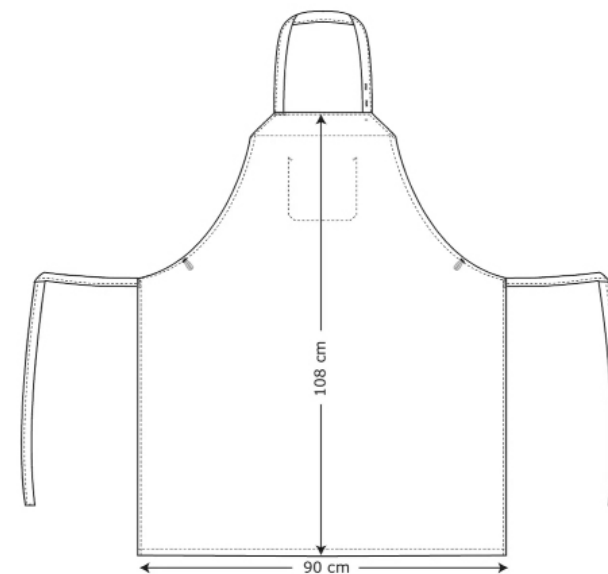

18,3

plastikflasker er
genanvendt i
dette forklæde



Vaskeriservice



STANDARD
100





MADE IN
GREEN



Classic Smækforklæde

- Justerbar nakkestropp
- Syede bånd
- Steamerstropper

Størrelser	69 x 100 cm
Materiale	65% polyester / 35% bomuld
Kvalitet	210 g/m ²
Leverandør	Kentaur
Certificering	Oeko-Tex standard 100 Oeko-Tex made in green Grüner Knopf ISO 15797

Varenr / Farve	12026 / Navy	
	12027 / Mocca	

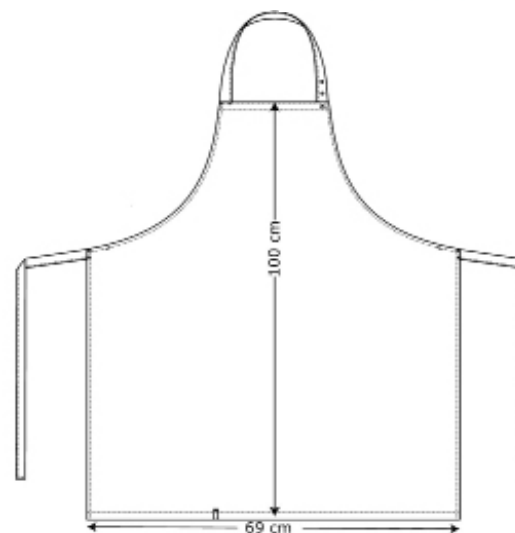

Vaskeriservice



STANDARD
100



MADE IN
GREEN

GRÜNER
KNOPF

SOZIAL ÖKOLOGISCH STAATLICH
UNABHÄNGIG ZERTIFIZIERT



Classic Smækforklæde med knap

- Justerbar nakkestroop
- Syede bånd
- Steamerstopper

Størrelser One size: B: 70 cm x H: 100 cm

Materiale 65% polyester / 35% BCI bomuld

Kvalitet 210 g/m²

Leverandør Kentaur

Certificering Oeko-Tex standard 100
Oeko-Tex made in green
Repreve
Grüner Knopf
ISO 15797

Varenr / Farve 12224 / Sand



26273 / Huntergreen

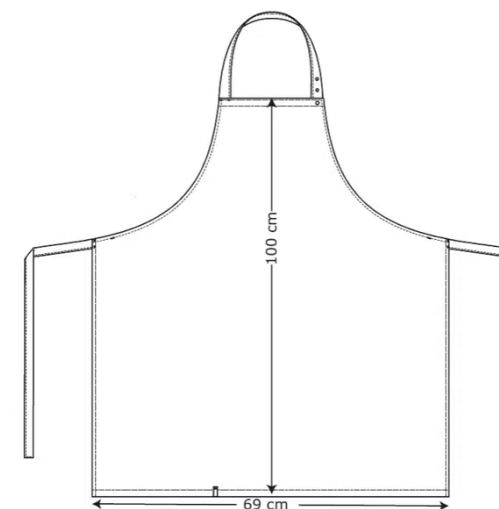

Vaskeriservice



STANDARD
100



MADE IN
GREEN

GRÜNER
KNOPF
SOZIAL. ÖKOLOGISCH. STAATLICH.
UNABHÄNGIG ZERTIFIZIERT.

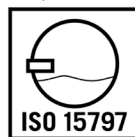

Classic

Forklæde med kryds

- Forklæde med ergonomisk krydsrem-design
- Justerbare seler
- Sidelomme med nøglestrop

Størrelser One size B: 70 x H: 100 cm

Materiale 65% genbrugspolyester / 35% genbrugsbomuld

Kvalitet 400 g/m²

Leverandør Segers

Certificering Oeko-Tex standard 100
Oeko-Tex made in green

Varenr / Farve 35801 / Oliven



35995 / Khaki



Vaskeriservice



STANDARD
100



MADE IN
GREEN





Tjener- og kokketøj

Pure



At noget er enkelt, er en kvalitet i sig selv. Pure er basistøj som bekræfter det vigtige i et solidt fundament og værdien af at holde i længden. Nogle gange er det enkle det bedste.

elis

Pure Kokkejakke kortærmet

- Korte ærmer
- Kinakrave
- Trykknapper

Størrelser	XXS - 3XL
Materiale	65% polyester/35% bomuld
Kvalitet	245 g/m ²
Leverandør	Kentaur
Certificering	Oeko-Tex standard 100 Oeko-Tex made in green Grüner Knopf ISO 15797

Varenr / Farve	1697 / Hvid	
	2817 / Sort	

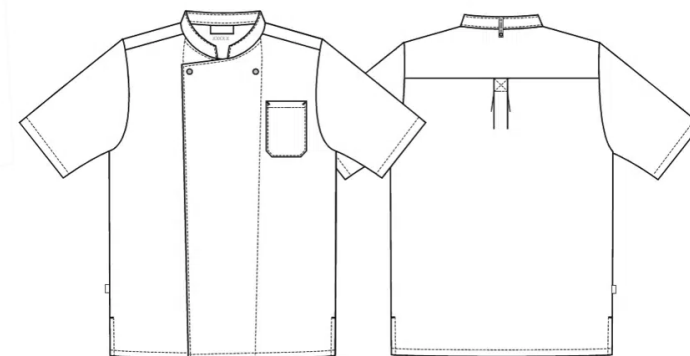

Vaskeriservice



STANDARD
100



MADE IN
GREEN

GRÜNER
KNOPF

SOZIAL, ÖKOLOGISCH, STAATLICH,
UNABHÄNGIG ZERTIFIZIERT.



Pure Kokkejakke kortærmet

- Korte ærmer
- Optimeret Unisex pasform – A-snit
- Trenset front med nem tilgang til trykknapper
- Nakkestrop til smækforklæde
- Skjulte trykknapper
- Penlomme på venstre ærme
- Slids i siderne

Størrelser XS - 4XL

Materiale 65% polyester/35% bomuld

Kvalitet 195 g/m2

Leverandør Kentaur

Certificering Oeko-Tex standard 100
ISO 15797

Varen / Farve 39171 / Hvid



39172 / Sort

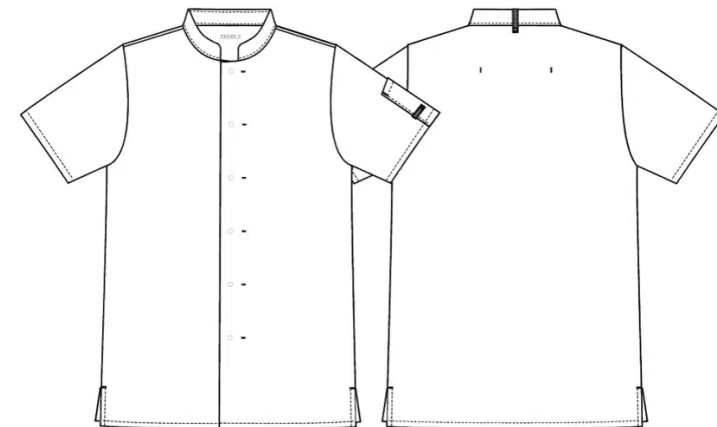

Vaskeriservice



STANDARD
100



Pure Kokkejakke langærmet

- Lange ærmer
- Optimeret Unisex pasform – A-snit
- Trenset front med nem tilgang til trykknapper
- Nakkestrop til smækforklæde
- Skjulte trykknapper
- Penlomme på venstre ærme
- Slids i siderne

Størrelser XS - 4XL

Materiale 65% polyester/35% bomuld

Kvalitet 195 g/m²

Leverandør Kentaur

Certificering Oeko-Tex standard 100
ISO 15797

Varen / Farve 39169 / Hvid



39170 / Sort

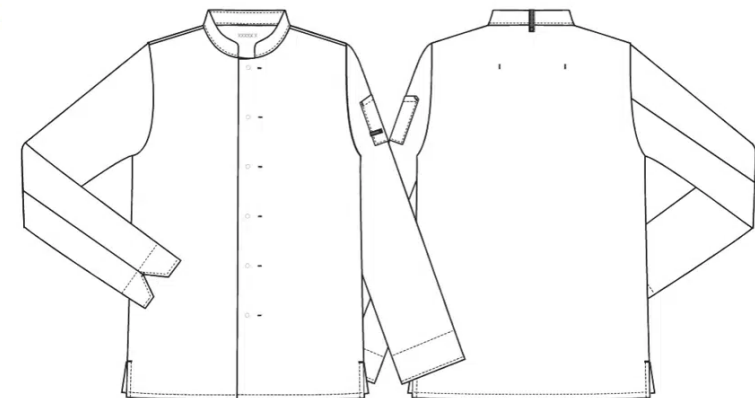

Vaskeriservice



STANDARD
100

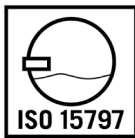

Pure

Bukser unisex

- Enkelt og rent design
- Høj komfort
- Fit, der passer til både herrer og damer
- Elastik i liv
- Integreerede lårommer

Størrelser	XXS - 5XL
Materiale	65% polyester / 35% bomuld
Kvalitet	210 g/m ²
Leverandør	EDSC
Certificering	Oeko-Tex standard 100
Varen / Farve	7389 / Sort 

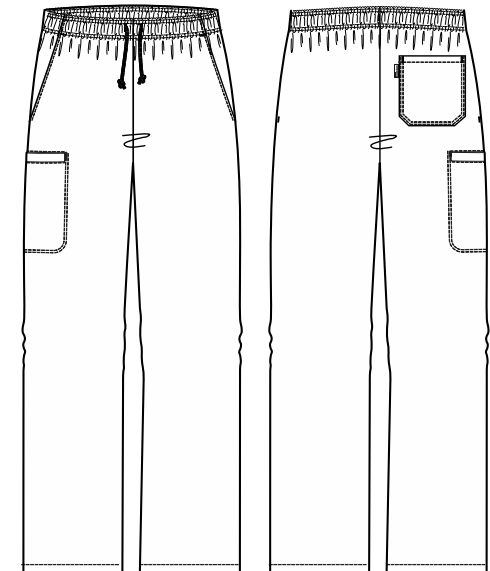

Vaskeriservice



STANDARD
100



Pure

Herrebuks

- Enkelt og rent design
- Høj komfort
- Bredt sortiment af størrelser
- Elastik i liv for ekstra komfortabelt fit
- Metalknaplukning i front

Størrelser 64-128

Materiale 65% polyester / 35% bomuld

Kvalitet 210 g/m²

Leverandør EDSC

Certificering Oeko-Tex standard 100

Varenr / Farve 3664 / Sort

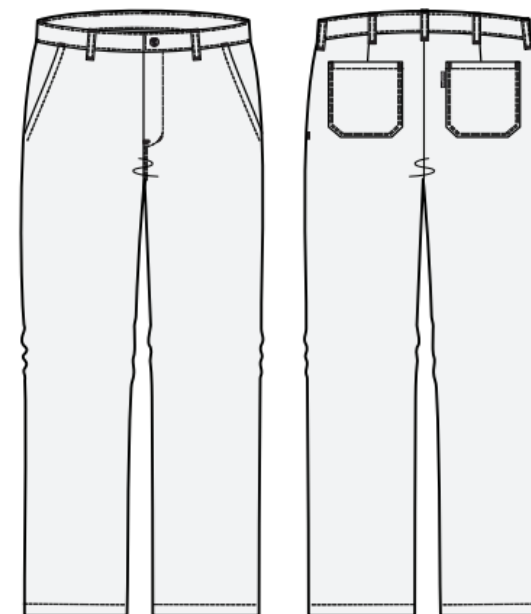

Vaskeriservice



STANDARD
100



Pure

Damebukser

- Enkelt og rent design
- Høj komfort
- Feminint fit
- Bredt sortiment af størrelser
- Elastik i liv for ekstra komfortabelt fit
- Metalknaplukning i front

Størrelser 34-58

Materiale 65% polyester / 35% bomuld

Kvalitet 210 g/m²

Leverandør EDSC

Certificering Oeko-Tex standard 100

Varenr / Farve 3588 / Sort

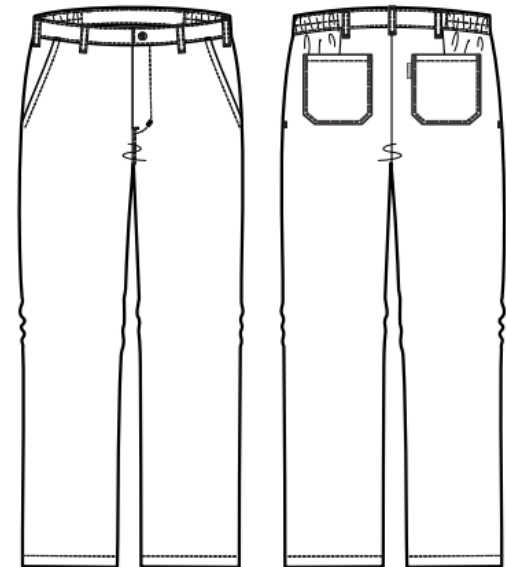

Vaskeriservice



STANDARD
100



Pure

Bager/cafe forklæde

- Bindebånd
- Lomme på højre lår

Størrelser	Onesize B:47 x H:78 cm
Materiale	65% polyester / 35% bomuld
Kvalitet	210 g/m2
Leverandør	Nybo
Certificering	Oeko-Tex standard 100
Varenr / Farve	3556 / sort 



Vaskeriservice



STANDARD
100



Pure Forstykke

- Syede bånd

Størrelser	Onesize: 70 x 70 cm
Materiale	65% polyester / 35% bomuld
Kvalitet	245 g/m ²
Leverandør	Kentaur
Certificering	Oeko-Tex standard 100 Oeko-Tex made in green Grüner Knopf ISO 15797
Varenr / Farve	11506 / Sort 

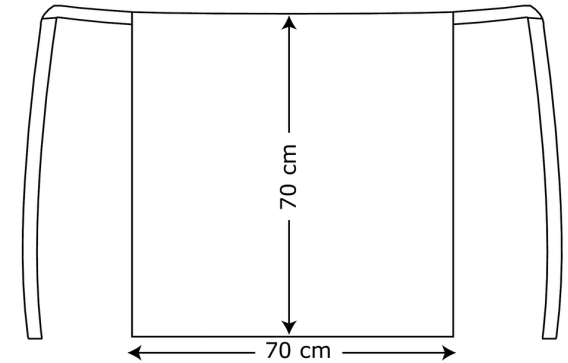

Vaskeriservice



STANDARD
100



MADE IN
GREEN

GRÜNER
KNOPF

SOZIAL, ÖKOLOGISCH, STAATLICH,
UNABHÄNGIG ZERTIFIZIERT.



Forklæde med smæk

- Bindebånd
- Justerbar nakkestroop med trykknop

Størrelser 90 x 110 cm

Materiale 65% polyester / 35% bomuld

Kvalitet 210 g/m²

Certificering Oeko-Tex standard 100

Varenr / Farve 5740 / Sort

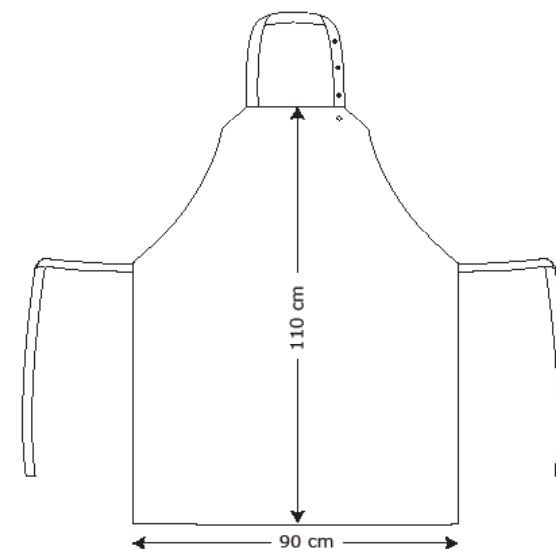

Vaskeriservice



STANDARD
100



Pure Forklæde med smæk

- Lomme på front
- Justerbar nakkestrop med trykknop

Størrelser	90 x 60 cm
Materiale	65% polyester / 35% bomuld
Kvalitet	210 g/m ²
Leverandør	Kentaur
Certificering	Oeko-Tex standard 100 Oeko-Tex made in green Grüner Knopf ISO 15797

Varenr / Farve 3212 / Sort ●

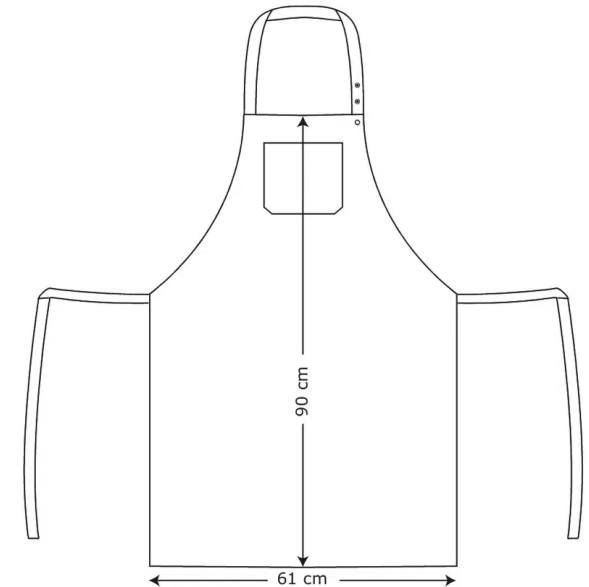

Vaskeriservice



STANDARD
100



MADE IN
GREEN

GRÜNER
KNOPF

SOZIAL, ÖKOLOGISCH, STAATLICH,
UNABHÄNGIG ZERTIFIZIERT.

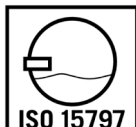

Pure Forklæde m. smæk

- Indvendig brystlomme
- Syede bånd
- Nakkestrop

Størrelser 90 X 110

Materiale 65% polyester / 35% bomuld

Kvalitet 245 g/m²

Leverandør Kentaur

Certificering Oeko-Tex standard 100
ISO 15797

Varenr / Farve 7331 / Hvid 

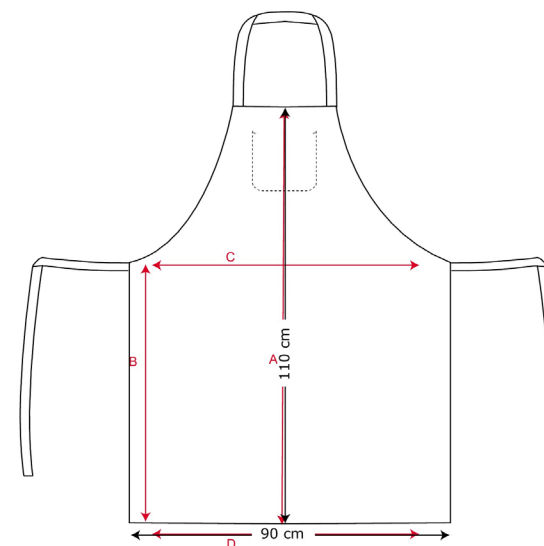

Vaskeriservice



STANDARD
100

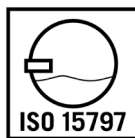



Tjener- og kokketøj

Serve



Den følelse der serveres for gæsterne, er den følelse personalet bærer rundt på. Serve er en kollektion skabt for at hårdt arbejde skal føles som en luksus. Når dagen er slut, kan et stykke tøj have gjort hele forskellen.

Serve

Serverings skjorte, unisex

- Klassisk snit
- Lange ærmer
- Indvendig strop til opsmøg på ærmer
- En brystlomme
- Slids i siderne

Størrelser	XS - 4XL
Materiale	65% polyester / 35% bomuld
Kvalitet	150 g/m ²
Leverandør	Kentaur
Certificering	Oeko-Tex standard 100 Oeko-Tex made in green Grüner Knopf ISO 15797

Varenr / Farve	3849 / Sort	
	6910 / Hvid	

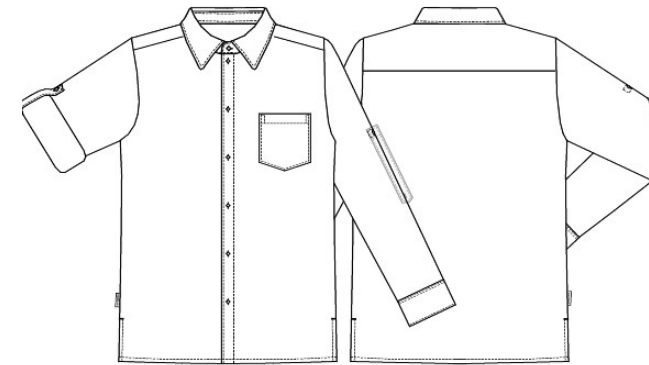

Vaskeriservice



STANDARD 100



MADE IN GREEN

GRÜNER KNOPF

SOZIAL ÖKOLOGISCH STAATLICH UNABHÄNGIG ZERTIFIZIERT



Serve

Serverings skjorte dame

- Figursyet skjorte med indsnit
- 7/8 ærmer

Størrelser	XS - 4XL
Materiale	65% polyester / 35% bomuld
Kvalitet	150 g/m2
Leverandør	Kentaur
Certificering	Oeko-Tex standard 100 Oeko-Tex made in green Grüner Knopf ISO 15797

Varenr / Farve	3848 / Sort	
	6905 / Hvid	

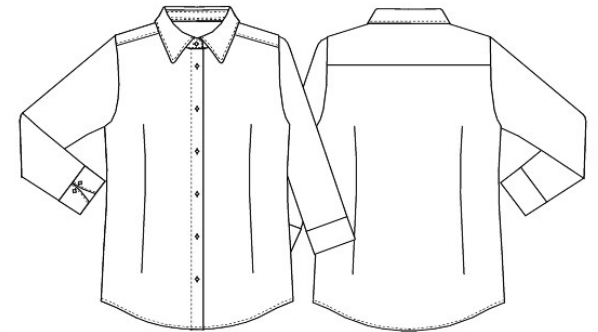

Vaskeriservice



STANDARD
100



MADE IN
GREEN

GRÜNER
KNOPF

SOZIAL ÖKOLOGISCH STAATLICH
UNABHÄNGIG ZERTIFIZIERT



Serve

Hybrid skjorte

Dame slim

- Nyfortolkning af den klassiske skjorte
- Kombinerer de nyeste teknologier med gennemtestet og bæredygtig fiber produktion
- Blødhed mod huden
- Fire-vejs ultra stræk
- Åndbarhed og temperatur regulerende egenskaber

Størrelser S - 4XL

Materiale 46% modal / 30% lyocell / 17% polyester / 7% elastane lycra

Kvalitet 185 g/m2

Leverandør ID

Certificering Oeko-Tex standard 100

Varenr / Farve 35175 / Hvid



35763 / Sort



35177 / Navy



Vaskeriservice



STANDARD
100



Serve

Hybrid skjorte

Herre modern fit

- Nyfortolkning af den klassiske skjorte
- Kombinerer de nyeste teknologier med gennemtestet og bæredygtig fiber produktion
- Blødhed mod huden
- Fire-vejs ultra stræk
- Åndbarhed og temperatur regulerende egenskaber

Størrelser S - 4XL

Materiale 46% modal / 30% lyocell / 17% polyester / 7% elastane lycra

Kvalitet 185 g/m2

Leverandør ID

Certificering Oeko-Tex standard 100

Varenr / Farve 35877 / Hvid



35773 / Sort



Vaskeriservice



STANDARD
100



Serve

Hybrid skjorte

Herre slim fit

- Nyfortolkning af den klassiske skjorte
- Kombinerer de nyeste teknologier med gennemtestet og bæredygtig fiber produktion
- Blødhed mod huden
- Fire-vejs ultra stræk
- Åndbarhed og temperatur regulerende egenskaber

Størrelser S - 2XL

Materiale 46% modal / 30% lyocell / 17% polyester / 7% elastane lycra

Kvalitet 185 g/m2

Leverandør ID

Certificering Oeko-Tex standard 100

Varenr / Farve 35171 / Hvid



35762 / Sort



35178 / Navy



Vaskeriservice



STANDARD
100



Serve

Slå-om kjole "stuepige"

- Dame model
- 2 hoftefølommer
- Ingen ærmer

Størrelser	2XS - 5XL
Materiale	65% polyester / 35% bomuld
Kvalitet	215 g/m ²
Leverandør	Nybo
Certificering	Oeko-Tex standard 100
Varenr / Farve	11616 / Sort 



Vaskeriservice



STANDARD
100



Serve

Dame Wellness tunika

- Dame model
- Asiatisk inspireret stil
- Mange smarte detaljer
- Behagelig metervare
- Store, dybe lommer
- Indvendig nakkestroop
- Slidser for bedre komfort
- Praktiske nøglestropper
- Justering på ærmerne giver god fleksibilitet

Størrelser 2XS - 5XL

Materiale 65% polyester / 32% bomuld / 3% EOL-stretch

Kvalitet 215 g/m²

Leverandør Nybo

Certificering Oeko-Tex standard 100
Oeko-Tex Made in Step

Varenr / Farve 12440 / Sort



Vaskeriservice



STANDARD
100



STeP



Serve

Kjole slå-om stretch

- Dame model
- Indeholder genanvendt polyester fra PET-flasker
- 4-way power fit stretch
- Heat resistant Creora® Power fit elastane
- Enkelt og let design
- 2 sidelommer
- Justerbar talje

Størrelser 34-60

Materiale 90% polyester / 10% EOL-stretch

Kvalitet 220 g/m²

Leverandør Kentaur

Certificering Oeko-Tex standard 100
Oeko-Tex made in green
Grüner Knopf
ISO 15797
REPREVE - recycled polyester

Varenr / Farve 35800 / Dark night

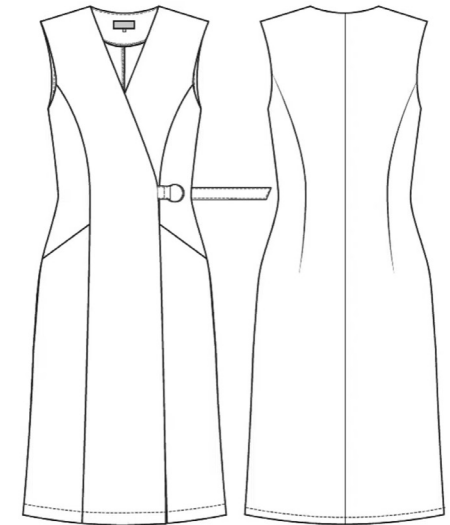

Vaskeriservice



STANDARD
100



MADE IN
GREEN

GRÜNER
KNOPF

SOZIAL, ÖKOLOGISCH, STAATLICH,
UNABHÄNGIG ZERTIFIZIERT.



Serve T-shirt ProWear

- Slidstærk og farveægte kvalitet
- Firelags halsrib
- Rund hals
- Klassisk og pæn t-shirt, der passer alle

Størrelser	S - 6XL
Materiale	60% bomuld / 40% polyester
Kvalitet	210 g/m ²
Leverandør	ID
Certificering	Oeko-Tex standard 100
Varenr / Farve	1083 / Hvid 
	5257 / Sort 

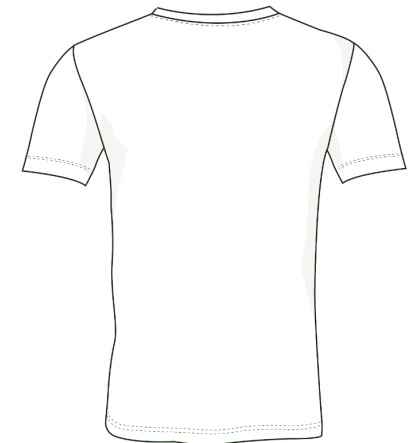
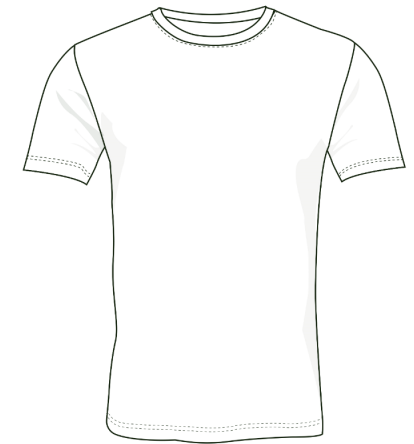

Vaskeriservice





STANDARD
100



Serve T-shirt ProWear

- Ekstra slidstærk dame t-shirt
- Rund hals og slids i siden
- Let figursyet
- Ekstra stabilitet
- Lang levetid

Størrelser	XS - 6XL
Materiale	60% bomuld / 40% polyester
Kvalitet	210-220 g/m2
Leverandør	ID
Certificering	Oeko-Tex standard 100

Varenr / Farve	10981 / Hvid	
	8376 / Sort	

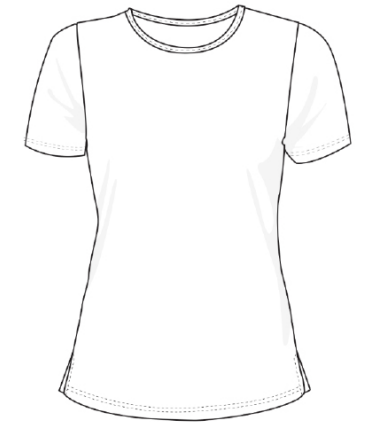

Vaskeriservice



STANDARD
100



Serve

T-shirt PRO Wear Light

- Damemodel
- Rund hals
- Ekstra slidstærk
- T-shirt i en lettere metervare
- Fire-lags halsrib, nakke- og skulderbånd og nakkespejl

Størrelser	XS - 6XL
Materiale	50% bomuld / 50% polyester
Kvalitet	175 g/m ²
Leverandør	ID
Certificering	Oeko-Tex standard 100
Varenr / Farve	27856 / Hvid 
	30186 / Sort 



Vaskeriservice



STANDARD
100



Serve

T-shirt PRO Wear Light

- Unisexmodel
- Rund hals
- Ekstra slidstærk
- T-shirt i en lettere metervare
- Fire-lags halsrib, nakke- og skulderbånd og nakkespejl

Størrelser	XS - 6XL
Materiale	50% bomuld / 50% polyester
Kvalitet	175 g/m ²
Leverandør	ID
Certificering	Oeko-Tex standard 100
Varenr / Farve	27861 / Hvid 
	30040 / Sort 



Serve

T-shirt Pro Wear Care

- Unisexmodel
- Slidstærk t-shirt med naturlig O-hals
- Smal hals- og ærmerib
- Ekstra forstærkning af nakke- og skuldर्सøm
- Casual design og flot fitted pasform
- Lang levetid

Størrelser XS - 6XL

Materiale 60% BCI-indkøbt bomuld / 40% genbrugspolyester

Kvalitet 210-220 g/m²

Leverandør ID

Certificering Oeko-Tex standard 100
Ecolabel
ISO 15797

Varenr / Farve 27602 / Hvid



26518 / Sort

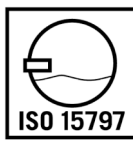

Serve

Poloshirt ProWear

- Slidstærk i Prowear kvalitet
- Klassisk model
- Brystlomme
- Stolpelukning med knapper
- Fås i mange farver

Størrelser	XS - 6XL
Materiale	50% bomuld / 50% polyester
Kvalitet	220 g/m ²
Leverandør	ID
Certificering	Oeko-Tex standard 100
Varenr / Farve	10988 / Hvid 
	10989 / Sort 

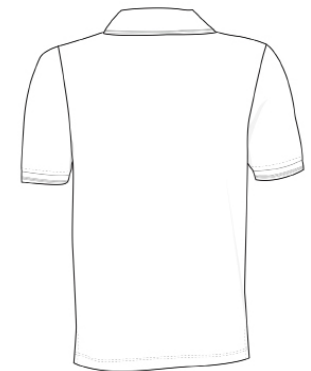

Vaskeriservice



STANDARD
100



Serve

Damebukser m. elastik

- Damemodel
- To sidelommer
- Elastik bagpå
- Lukning med metaltrykknapper og lynlås

Størrelser 32-76

Materiale 65% Polyester / 35% bomuld

Kvalitet 245 g/m²

Leverandør EDSC

Certificering Oeko-Tex standard 100

Varenr / Farve 4154 / Hvid

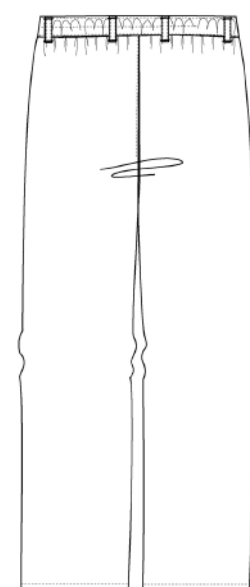
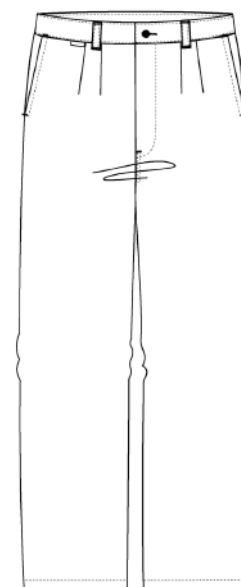

Vaskeriservice



STANDARD
100



Serve

Ventebukser

- To sidelommer
- To baglommer
- En lårlomme med plads til kuglepen
- Mobilomme på venstre side
- Blødt materiale ved mave

Størrelser 34 - 54, D18 - D27

Materiale 65% genanvendt polyester / 35 % bomuld

Kvalitet 195 g/m²

Leverandør EDSC

Certificering Oeko-Tex standard 100

Varenr / Farve 12338 / Sort

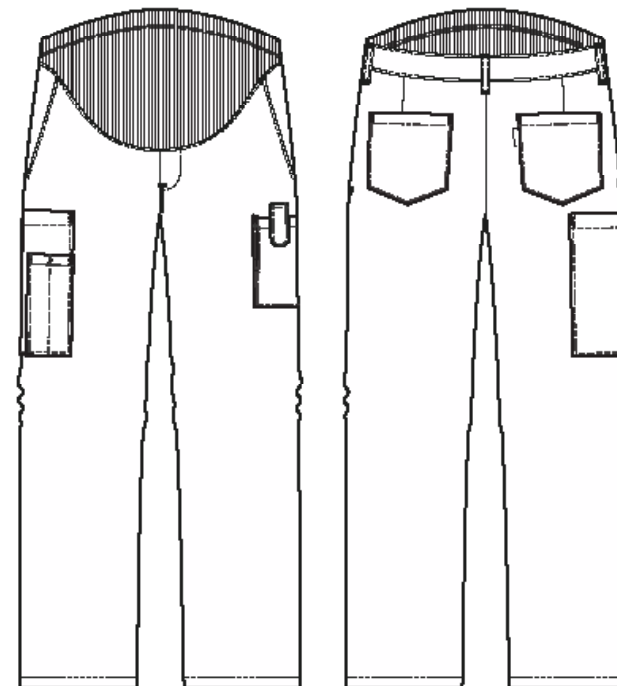

Vaskeriservice



STANDARD
100



Serve

Termojakke

Whitby - Originals

- God pasform
- Slidstærk
- God isoleringsevne
- Varmen holdes tæt til kroppen

Størrelser	XS - 4XL
Materiale	100% polyester
Kvalitet	370 g/m ²
Leverandør	Mascot
Certificering	Oeko-Tex standard 100
Varenr / Farve	23518 / Hvid 



Vaskeriservice



STANDARD
100



Serve

Termovest

Mirabel - Originals

- God pasform
- Slidstærk
- God isoleringsevne
- Varmen holdes tæt til kroppen

Størrelser	XS - 4XL
Materiale	100% polyester
Kvalitet	370 g/m ²
Leverandør	Mascot
Certificering	Oeko-Tex standard 100
Varenr / Farve	0221 / Hvid 



Vaskeriservice



STANDARD
100



Serve Termojakke

- Ultralydssvejset quilt med polyestervat er meget isolerende og mere holdbart end syet quilt.
- Let buende krave med indvendig rib, som slutter tæt til i halsen og holder kulden ude.
- Forlommer med lynlås for sikker opbevaring.
- Ekstra beskyttelse mod kulde med forlænget ryg
- Rib i nedre kant og ved håndled

Størrelser	XS - 4XL
Materiale	100% polyester
Kvalitet	275 g/m ²
Leverandør	Mascot
Certificering	Oeko-Tex standard 100
Varenr / Farve	22111 / Marine 



Vaskeriservice



STANDARD
100



Serve Tørklæde

- Regulérbar elastik der holder tørklædet på plads
- Behageligt og klassisk tørklæde der passer alle
- Findes i 3 farver, så der er mulighed for at matche det resterende sortiment

Størrelser	One size
Materiale	100% polyester
Kvalitet	75 g/m ²
Leverandør	Kentaur
Certificering	Oeko-Tex standard 100
Varenr / Farve	0590 / Hvid 



Vaskeriservice



STANDARD
100

